

P2 Literacy 1B classwork week 4

Monday, 29th June, 2020

Lesson One

New words

Bed sheets, curtains, carpet, pillow, wardrobe, mattress, bedcover, dustbin

Things in the bedroom

Bedsheets

Wardrobe

Shoes

Pillow

Clothes

tables

Curtains

Chairs

Carpet

Spoons

Mattress

Activity

1. Name these things found in bed room.

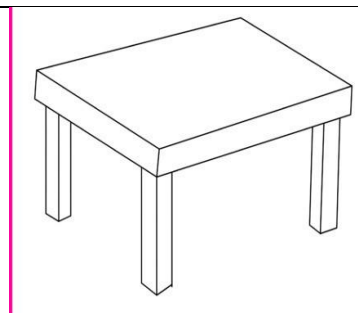
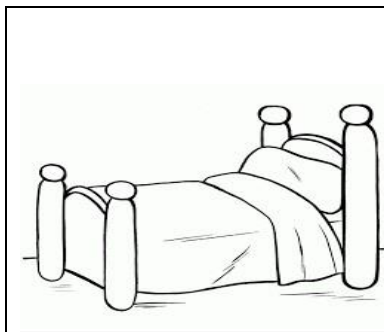

2. Write down four things found in a bed room.

3. How is a bed useful in a home?

Tuesday, 30th June, 2020

Lesson two

Things in the toilet



scrubbing brush

brush

broom

rag

soap

| | |
|---|--|
|  |  |
| Soap | Brush |

Activity



1. List down four things found in the toilet.
2. Draw and name things found in a toilet.
3. Write down one use of soap in a home.

Wednesday, 1st July, 2020

Lesson three

Things in the sitting room

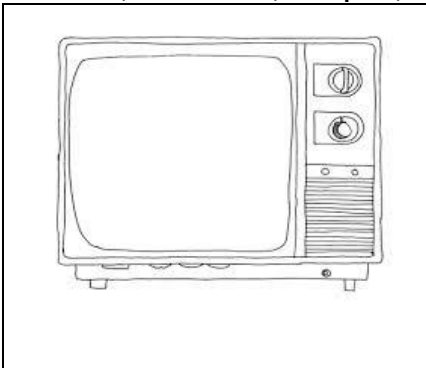
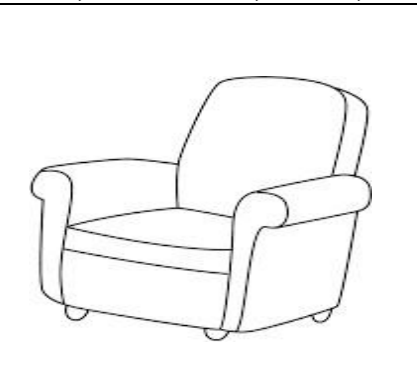
Chairs, curtains, carpet, tables, television, table, cloth.

| | | |
|---|--|---|
|  |  |  |
| Television | Chair | curtain |

Activity:

1. How is a chair useful in a home?
2. Naming things found in the;
 - a) Bedroom
 - b) Sitting room
 - c) Kitchen
3. List down three things found in a sitting room.

Thursday, 2nd July, 2020

Lesson four**New words**

Factory, bush, industry, thread, iron sheets

Materials used and their sources.

| Material | Sources |
|-----------------------------------|----------------------|
| - Sisal | - Sisal plants |
| - Banana fibres | - Banana plants |
| - Palm leaves | - Palm trees |
| - Papyrus , clay soil , raffia | - Swamps |
| - Reeds , grass , straws , sticks | - Brush , forest |
| - Nails , iron sheets , plastics | - Factory , industry |
| - Blocks | - Clay soil |
| - Bricks | - Soil |
| - Mud | |
| - Threads , needles , straws | - shop |

Activity

1. From the circle below, sort out the things we make.

*bricks, pestle, lake,
dog, pumpkin, rabbit, plate basket,
plants, water, classroom, bed, table, insect*

2. Match correctly.

Sisal

banana fibres

palm leaves

threads, needle, straws

factory

palm tree

banana plants

sisal plant

Friday, 3rd July, 2020

Lesson five

New words

Promoting, purposes, decoration, heritage, culture, cultural skills, sold
Importance/use of the things we make.

| Things made | Uses of these things. |
|--|---|
| - Chairs , benches , stools , mats | For sitting on |
| - Balls , toys , ropes | For playing with |
| - Pots , mats , baskets , table clothes | For learning purposes For decoration |
| - Baskets , pots , mats | For promoting culture |
| - Pots , tables , beds , mats , baskets, ropes , chairs | Are sold to get money |
| Spoons, cups, plates, stones, baskets, pots | They are used at home and at school |
| - Sandals(made from tyres) | For wearing |

Activity.

1. Match the things we make to their uses.

- | | |
|-------|------------------|
| Dolls | for wearing |
| Mats | for sleeping on |
| Beds | for playing with |
| Shoes | for sitting on |

2. Read and spell the words.

Promoting, purposes, decoration, heritage, culture, cultural skills, sold

